



# Penthouse

008.001.002.001



**blue rabbit**

© 2017

Blue Rabbit 2.0 - Hemelrijken 8 - B-2890 St-Amands - Belgium.  
Copyrighted material - Do not reproduce under penalty of law.

## Front

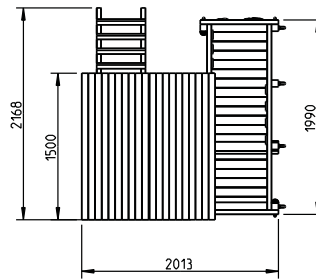
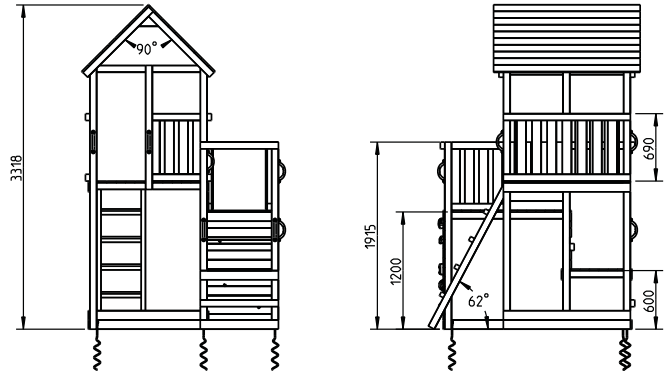

## Back

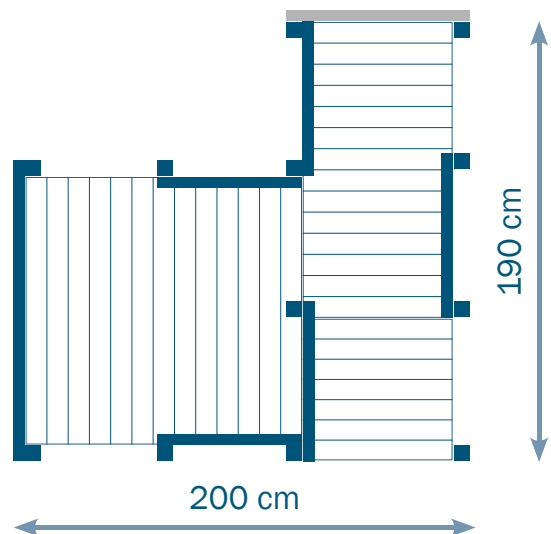

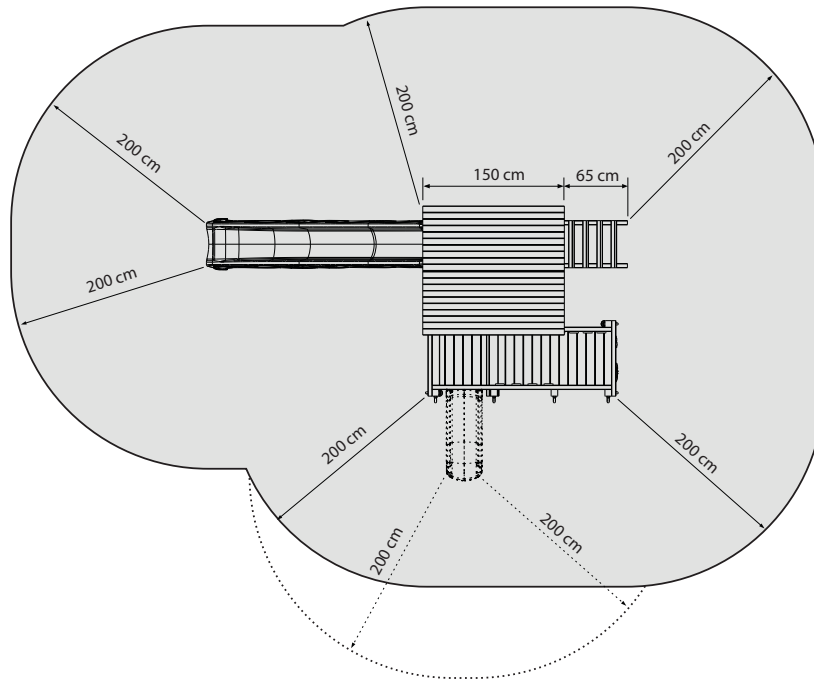

						<b>@ramp</b> 008.003.002.001 	<b>@challenger</b> 008.003.007.001 					
		<b>@platform</b> 008.003.006.001 	<b>@net</b> 008.003.003.001 	<b>@bridge</b> 008.003.004.001 	<b>@steps</b> 008.003.008.001 	<b>@wall</b> 008.003.001.001 	<b>@swing</b> 008.003.005.001 					
<b>Penthouse</b> 008.001.002.001 	⊙	⊙	A ⊙ B	⊖	⊖	A ⊙ B ⊙ C	A ⊙ B ⊙ C	A ⊙ B	⊙	⊖	⊖	X

**blue rabbit 2.0**

**blue rabbit 2.0**

?

?

53 x 28 x 19 cm	11,5 kg	42	120 x 80 x 148 cm	508 kg
-----------------	---------	----	-------------------	--------



30 mm - 45 mm - 80 mm



45 mm - 80 mm

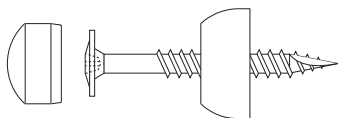

80 mm

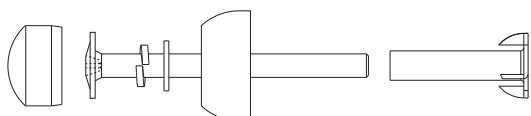

90 / 110 mm

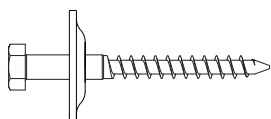

70 mm



40 mm

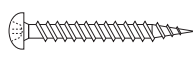

30 mm

13x









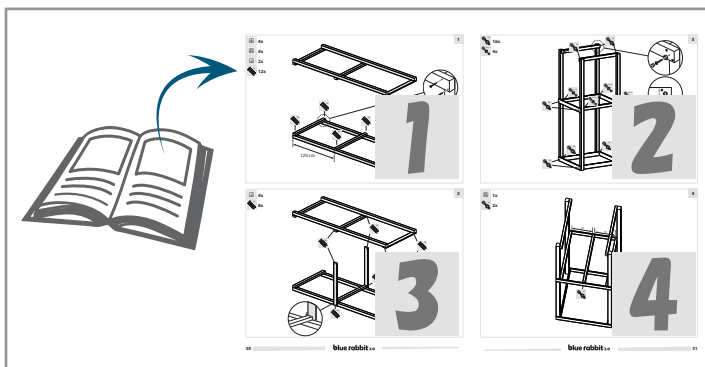









3x



1x



5x	<b>A</b>	min 68 mm max 90 mm		270 cm
		min 68 mm max 90 mm		
4x	<b>B</b>	min 68 mm max 90 mm		192 cm
		min 68 mm max 90 mm		
2x	<b>C</b>	min 68 mm max 90 mm		127 cm
		min 68 mm max 90 mm		
1x	<b>D</b>	min 68 mm max 90 mm		77 cm
		min 68 mm max 90 mm		
1x	<b>E</b>	min 68 mm max 90 mm		190 cm
		min 32 mm max 50 mm		
2x	<b>F</b>	min 68 mm max 90 mm		166 cm
		min 32 mm max 50 mm		
2x	<b>G</b>	min 68 mm max 90 mm		130 cm
		min 32 mm max 50 mm		
2x	<b>H</b>	min 68 mm max 90 mm		min 128 / max 130 cm
		min 32 mm max 50 mm		
6x	<b>I</b>	min 68 mm max 90 mm		120 cm
		min 32 mm max 50 mm		
2x	<b>J</b>	min 68 mm max 90 mm		95 cm
		min 32 mm max 50 mm		
2x	<b>K</b>	min 68 mm max 90 mm		min 86 / max 88 cm
		min 32 mm max 50 mm		
4x	<b>L</b>	min 68 mm max 90 mm		80 cm
		min 32 mm max 50 mm		
1x	<b>M</b>	min 68 mm max 90 mm		71 cm
		min 32 mm max 50 mm		
4x	<b>N</b>	min 68 mm max 90 mm		69 cm
		min 32 mm max 50 mm		
1x	<b>O</b>	min 68 mm max 90 mm		min 67 / max 69 cm
		min 32 mm max 50 mm		
1x	<b>P</b>	min 68 mm max 90 mm		63 cm
		min 32 mm max 50 mm		
4x	<b>Q</b>	min 68 mm max 90 mm		min 61 / max 63 cm
		min 32 mm max 50 mm		

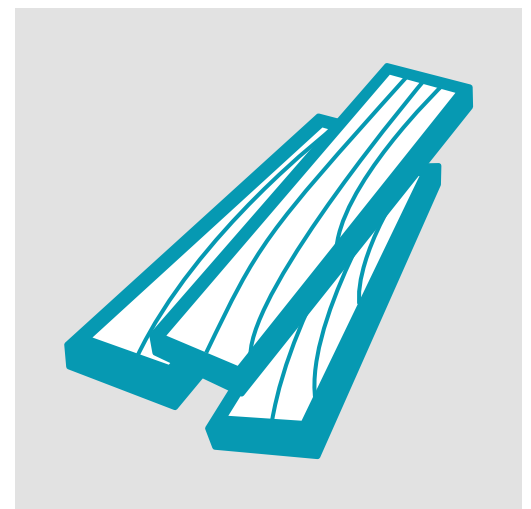
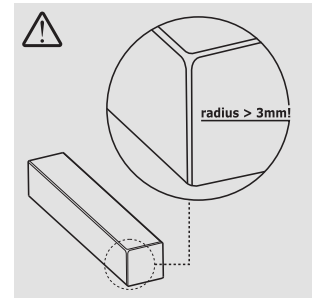

4x **R** min 44 mm | max 45 mm  50 cm

min 44 mm  
max 45 mm

2x **S** min 95 mm | max 145 mm  190 cm

min 15 mm  
max 22 mm

14x\*/20x\*\* **T** \*\* min 95 mm | \* max 145 mm  150 cm

min 15 mm  
max 22 mm

6x **U** min 95 mm | max 145 mm  130 cm

min 15 mm  
max 22 mm

4x **V** min 95 mm | max 145 mm  120 cm

min 15 mm  
max 22 mm

8x\*/12x\*\* **W** \*\* min 95 mm | \* max 145 mm  min 112 / max 116 cm

min 15 mm  
max 22 mm

17x\*/21x\*\* **X** \*\* min 95 mm | \* max 145 mm  80 cm

min 15 mm  
max 22 mm

17x\*/26x\*\* **Y** \*\* min 95 mm | \* max 145 mm  69 cm

min 15 mm  
max 22 mm

15x\*/22x\*\* **Z** \*\* min 95 mm | \* max 145 mm  min 62 / max 66 cm

min 15 mm  
max 22 mm

1x\*/2x\*\* **1** \*\* min 95 mm | \* max 145 mm  64 cm



min 15 mm  
max 22 mm

1x **2** min 95 mm | max 145 mm  min 51 / max 55 cm

min 15 mm  
max 22 mm

1x **3** min 95 mm | max 145 mm  min 52 / max 54 cm

min 15 mm  
max 22 mm

2x **4** min 95 mm | max 145 mm   40 cm  
min 15 mm  
max 22 mm

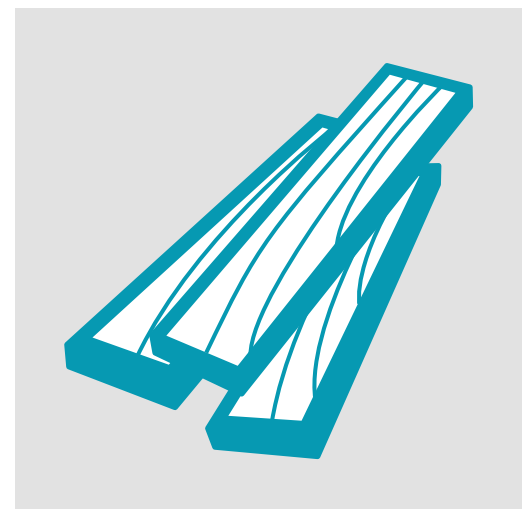
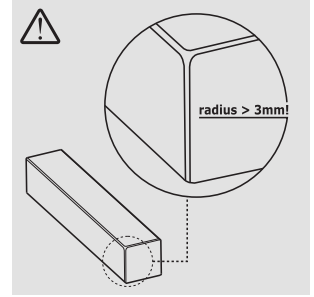



---

Blue Rabbit 2.0®  
Hemelrijken 8  
B-2890 Sint-Amands  
BELGIUM

[info@bluerabbit.be](mailto:info@bluerabbit.be)

[www.bluerabbit.be](http://www.bluerabbit.be)